

Alfa Laval SaniMega SB

Rotary Spray Head

Introduction

The Alfa Laval SaniMega SB is a rotary spray head tank cleaning machine for hygienic environments. Designed to clean tanks from 40 - 400 m³.

The Alfa Laval SaniMega SB minimizes the consumption of water and cleaning media. Easy to customize to meet customer requirements, the SaniMega SB allows companies to spend less time cleaning and more time producing.

The SaniMega SB is authorized to carry the 3-A symbol.

Application

The Alfa Laval SaniMega SB is designed for the removal of residues from hygienic tanks across the dairy, brewery, distillery, beverage, food, personal care and many other industries.

Benefits

- 40% faster cleaning = more time for production
- Saves up to 40% of your cleaning cost
- Dynamic cleaning performance and 360° full wetting
- Easy to retrofit traditional spray balls to a more economical solution

Standard design

Different choice of spray patterns suitable for various applications and tank designs, ranging from simple tanks to more complex tanks with structures such as agitator and baffles. The SaniMega SB is lubricated by the cleaning media.

Working principle

The flow of the cleaning media causes the head of the Alfa Laval SaniMega SB to rotate, and the fan-shaped jets layout a swirling pattern throughout the tank or reactor. This generates the wetting/impact needed for the efficient removal of the residual product; the cascading flow covers all internal surfaces of the vessel.

Spray Pattern

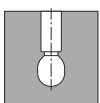

360°

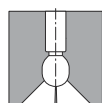

270° up



Certificates

2.2 materiale certificates, Q-doc, 3-A and ATEX.



TECHNICAL DATA

Lubricant:	Lubrication by rinse/cleaning fluid
Wetting radius:	Max. 6 m
Impact cleaning radius:	Max. 3 m

Pressure

Working pressure:	1 - 4 bar
Recommended pressure:	2 - 3 bar

PHYSICAL DATA

Materials

Metallic parts:	AISI 316L
Non-metallic parts:	PEEK 450G ¹

¹ FDA compliance 21CFR§177

Surface finish:	Ra 0.8 µm
-----------------	-----------

Temperature

Max. working temperature:	95 °C
Max. ambient temperature:	150 °C

Weight:	0.61 kg
---------	---------

Connections

Clip-on:	2" BPE US
Weld-on:	2" BPE US

Clip

Easy-on/off clip (Ø5.0 mm). Clip needed for both clip-on and weld-on versions to assemble the machine.

Recommended tank size:	50 - 350 m ³
------------------------	-------------------------

Qualification Documentation

Documentation specification

	Equipment Documentation includes:
Q-doc	<ul style="list-style-type: none">• EN 1935/2004 DoC• EN 10204 type 3.1 inspection Certificate and DoC• FDA DoC• GMP EC 2023/2006 DoC• EU 10/2011 DoC• ADI DoC• QC DoC
ATEX	ATEX approved machine for use in explosive atmospheres Category 1 for installation in zone 0/20 in accordance with Directive 2014/34/EU II 1G Ex h IIB 85 °C ...175 °C Ga II 1D Ex h IIIC T85 °C ...T140 °C Da
3-A	3-A number: 78-##. Spray Cleaning Devices

Flow Rate

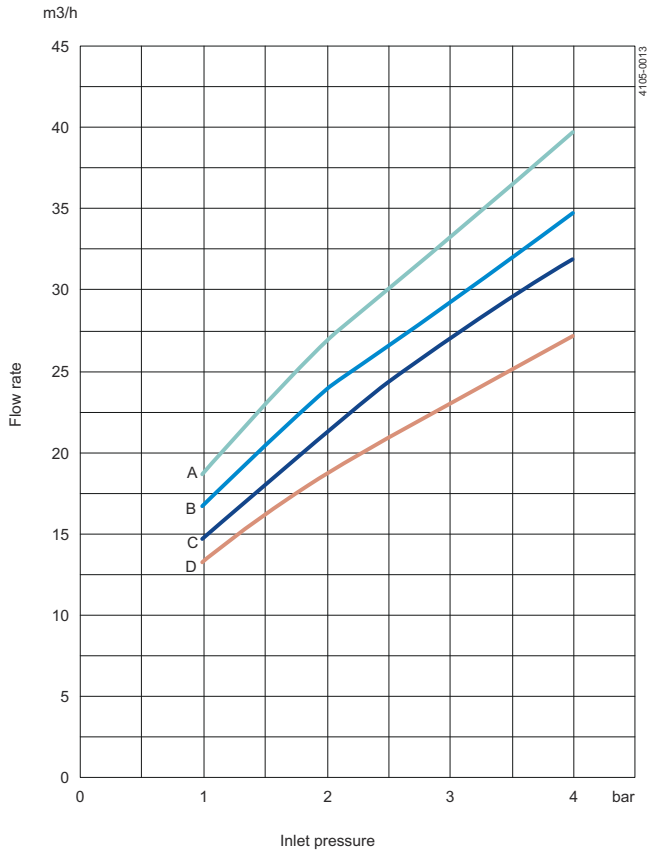

A = 360° High Flow D = 270°
 B = 270° High Flow
 C = 360°

Cleaning radius

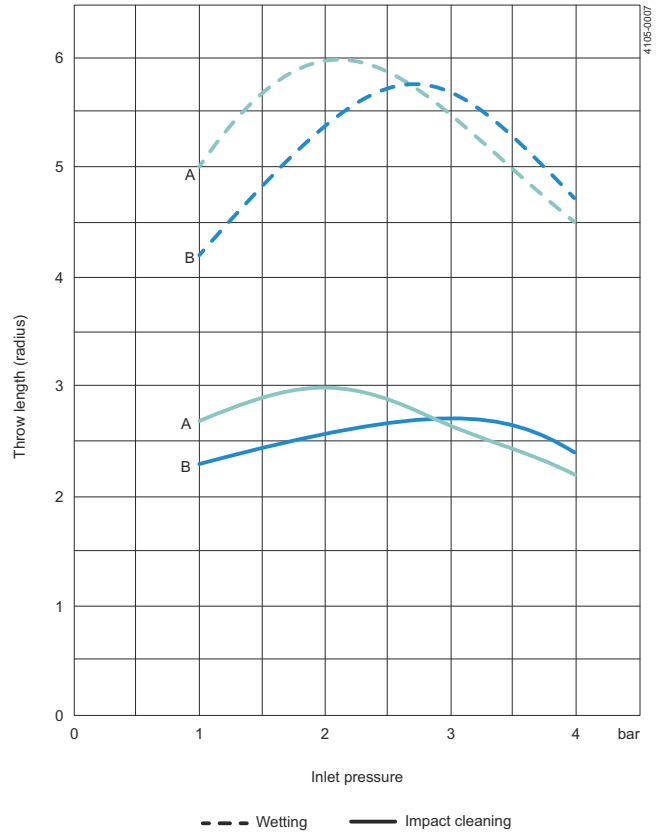

A = High flow 270°/360°
 B = 270°/360°

For Clip-on models, the flow rate is increased by approx. 2 m³/h

Dimensions (mm)

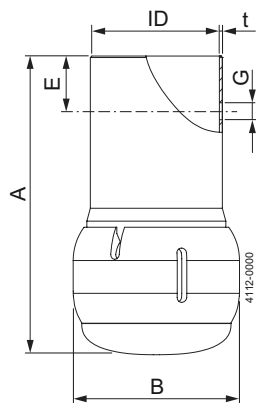

Clip-on

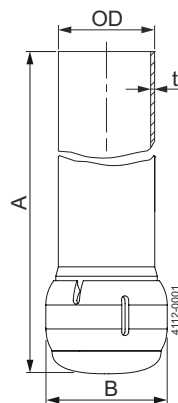

Weld-on

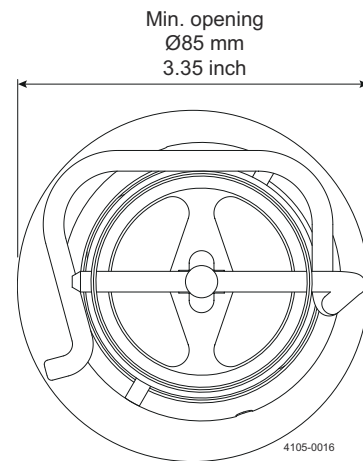

Type	A	B	G	E	ID	OD	t	Clip
Clip-on 2" BPE US	121	Ø67.4	Ø5.1	25.4	Ø51.1			Ø5.0
Weld-on ¹ 2" BPE US	141.6	Ø67.4				Ø50.8	1.2	

¹ Weld-on version only meets the requirements of the 3-A Hygienic Standard 78-# # if installed according to the user manual

This document and its contents are subject to copyrights and other intellectual property rights owned by Alfa Laval AB (publ) or any of its affiliates (jointly "Alfa Laval"). No part of this document may be copied, re-produced or transmitted in any form or by any means, or for any purpose, without Alfa Laval's prior express written permission. Information and services provided in this document are made as a benefit and service to the user, and no representations or warranties are made about the accuracy or suitability of this information and these services for any purpose. All rights are reserved.

200006938-3-EN-GB

© Alfa Laval

How to contact Alfa Laval

Up-to-date Alfa Laval contact details for all countries are always available on our website at www.alfalaval.com